



PRODUCT SPECIFICATION

PRODUCT: CERAMIC DISC CAPACITOR
SAFETY RECOGNIZED

TYPE: AH SERIES

CUSTOMER: _____

DOC. NO.: POE-D10-00-E-11

Ver.: 11

APPROVED BY CUSTOMER

VENDOR :



Record of change

Date	Version	Description	page
2008.6.3	1	1.D22-00-E-01(before) → POE-D10-00-E-01(1 st edition)	
2008.8.22	2	1 Complete lead code 2. Add last SAP code “ H” for halogen and Pb free , epoxy resin..	21 3
2008.12.12	3	1. Complete the 13 th to 17 th codes of SAP P/N. 2. Page layout adjustment.	4-5
2009.7.8	4	1 Change PSA & POE logo to Walsin & POE logo. 2.Complete Marking statement. 3.Revised standard NO. of SEV, SEMKO, FIMKO, NEMKO, DEMKO and KEMA. Revised recognized NO. of FIMKO, NEMKO, DEMKO and KEMA.	10 12
2009.9.14	5	1. H0: 18.0+2.0/-1.5 revised to 18.0+2.0/-0 2. “Protrusion length”: “+0.5to-1.0” revised to “2.0max (Or the end of lead wire may be inside the tape.)” 3. Add “250V~” under the “UL” mark according to the product’s marking.	9 9 10
2009.12.24	6	1. Marking 2. Correct X1 of recognized No by KTL. 3. Revised the Figure of impulse voltage test(Item 7.3.14) according to the standard IEC 60384-14 ed.3 4. Add “1AH” code for Y1:400V marking type.	10 11 14 4
2011.1.11	7	1. Review SAP P/N about diameter code: YU*AH561K100*→YU*AH561K080* 2. Delete “AT” taping type. 3. Add test item “Temperature Cycle ” . 4. Add item 10 “Drawing of internal structure and material list”	6 4,5,8,9 14 19
2011.5.12	8	1. Review the safety standards approval and recognized no. 2. Delete “old P/N” 3. Add the special marking for P/N:YP*AH102K100	10 5~6 9
2012.1.30	9	1. Review the approval rated voltage of UL and the marking.	8~9
2012/4/6	10	In order to improve the traceability of the product, change the date code on capacitor body, new date code can trace back to production “Lot No.”	8
2013/5/13	11	1. Review the Lead diameter ϕ from 0.60 +0.1/-0.05mm to 0.5+/-0.1mm 2. Add“3.1Norminal parts&3.2 special for surge parts” for “3. Part numbering/T.C/Capacitance/ Tolerance/Diameter” 3. In order the customer to know the round time of manufacture, change the date code on capacitor body, new date code can know the month of manufacture. 4. Delete “No marked with “ _ ” stand for Pb free”. 5. Delete “When the TCC is Y5V(YV), there is a “F” between the “AH” and capacitance code.” 6. Review the Solderability time from 2 \pm 0.5s to 5 \pm 0.5s	5,6,7 6 8 8 8 11

1. Part number for SAP system:

(Ex.) YU 0AH 472 M 13 0 L 20 C 0 B
 (1) (2) (3) (4) (5) (6) (7) (8) (9) (10) (11)

(1)Temperature characteristic (identified code)

CODE	CH(NP0)	SL	YP (Y5P)	YV(Y5V)	YU (Y5U)
Cap. Change	0±60PPM/°C	-1000~+350PPM/°C (+20°C~+85°C)	±10%	-80% ~ +30%	-55% to +20%

Remark(brevity code): Y5P→B、Y5V→F、Y5U→E

(2)TYPE (identified by 3-figure code) : 0AH = AH Type(X1:400V~/Y1:250V~),

1AH=AH Type(X1:400V~/Y1:400V~)

(3)Capacitance (identified by 3-figure code):EX.221=220pF

(4)Capacitance tolerance (identified by code): C:±0.25pF,D:±0.5pF,J:±5%,K:±10%,M:±20%

(5)Nominal body diameter dimension (identified by 3-figure code)

(6)Internal code: 0--Normal, other code--Special control

(7)Lead Style : Refer to “2. Mechanical”.

(8)Packing mode and lead length (identified by 2-figure code)

Taping Code	Description
AM	Ammo box and product pitch : 25.4 mm

Bulk Code	Description
3E	Lead length : 3.5mm
04	Lead length : 4.0mm
4E	Lead length : 4.5mm
20	Lead length : 20mm

(9)Length tolerance

Code	Description
A	±0.5 mm (only for kink lead type)
B	±1.0 mm
C	Min.
D	Taping special purpose

(10)Pitch

Code	Description
0	10±1 mm
A	10±0.5 mm

(11)Epoxy Resin Code

Code	Description
B	Pb free, Epoxy Resin
H	Halogen and Pb free, epoxy resin.

2. Mechanical:

Encapsulation : Epoxy resin, flammability UL94 V-0

Available lead code (unit: mm):

Lead type	SAP P/N (13-17)digits	Pitch (F)	Lead Length (L)	Packing	Lead Configuration
Lead style : L Type L Straight long lead	L20C0	10 ± 1.0	20 min.	Bulk	
Lead style : B Type B Straight long lead	BAMD0	10 ± 1.0	Refer to "4. Taping format"	Tap. Ammo	
Lead style : L Type L Straight short lead	L03B0	10 ± 1.0	3.0 ± 1.0	Bulk	
	L4EB0	10 ± 1.0	4.5 ± 1.0		
	L05B0	10 ± 1.0	5.0 ± 1.0		
Lead style : D Type D Vertical kink lead	D3EA0	10 ± 1.0	3.5 ± 0.5	Bulk	
	D04A0	10 ± 1.0	4.0 ± 0.5	Tap. Ammo	
	DAMD0	10 ± 1.0	Refer to "4. Taping format"		
Lead style : X Type X Outside kink lead	X3EA0	10 ± 1.0	3.5 ± 0.5	Bulk	
	X04A0	10 ± 1.0	4.0 ± 0.5		
	X05B0	10 ± 1.0	5.0 ± 1.0		
	XAMD0	10 ± 1.0	Refer to "4. Taping format"	Tap. Ammo	

 * Lead diameter Φd : $0.50 +0.1/-0.1$ mm

 *c (Coating **extension** on leads): 3.0mmMax for straight lead lead style, not exceed the kink for kink lead.

3. Part numbering/T.C/Capacitance/ Tolerance/Diameter :
3.1 Nominal parts:

SAP P/N	T.C.	Capacitance(pF)	Tolerance	Dimension (unit:mm)			
				D(max.)	T(max.)	F	Φd
CH*AH***C060*	CH (NP0)	2, 3,4, 5(pF)	±0.25pF	7.0	5.0	10±1	0.5±0.1
CH*AH***D060*		6,7,8,9,10(pF)	±0.5pF	7.0			
CH*AH120J060*		12		7.0			
CH*AH***J070*		15,18,20,22,24,27(pF)		8.0			
SL*AH***J060*	SL*	15,18,20,22,24,27,30, 33, 36, 39(pF)	±5%	7.0			
SL*AH***J070*		47,50,51, 56,62(pF)		8.0			
SL*AH***J080*		68,75,82(pF)		9.0			
SL*AH101J090*		100pF		10.0			
YP*AH101K060*	Y5P	100 pF	10%	7.0			
YP*AH151K060*		150 pF		7.0			
YP*AH221K060*		220 pF		7.0			
YP*AH331K060*		330 pF		7.0			
YP*AH471K070*		470 pF		8.0			
YP*AH561K080*		560 pF		9.0			
YP*AH681K080*		680 pF		9.0			
YP*AH102K100*		1000 pF		11.0			
YU*AH102M070*		Y5U		1000 pF	20%	8.0	
YU*AH152M080*	1500 pF		9.0				
YU*AH222M090*	2200 pF		10.0				
YU*AH332M110*	3300 pF		12.0				
YU*AH392M120*	3900 pF		14.0				
YU*AH472M130*	4700 pF		14.0				
YV*AH102M060*	Y5V	1000pF		7.0			
YV*AH152M070*		1500pF		8.0			
YV*AH222M080*		2200pF		9.0			
YV*AH332M100*		3300pF		11.0			
YV*AH472M110*		4700pF		12.0			

- The minimum thickness of coating (reinforced insulation) is 0.4mm.

3.2 Special for surge parts:

Part Number	Temp. Char.	Cap.(pF)	Tol.	Dimension (mm)			
				D Max.	T Max.	F±1	Wire Dia. (φd)
YP *AH101K06S	Y5P	100	10%	7.0	6.0	10.0	0.5±0.1
YP *AH151K06S		150		7.0			
YP *AH221K06S		220		7.0			
YP *AH331K07S		330		8.0			
YP *AH471K08S		470		9.0			
YP *AH681K09S		680		10.0			
YP *AH102K11S		1000		12.0			
YU*AH102M07S	Y5U	1000	20%	8.0	6.0	10.0	0.5±0.1
YU*AH152M08S		1500		9.0			
YU*AH222M09S		2200		10.0			
YU*AH332M11S		3300		12.0			
YU*AH392M12S		3900		14.0			
YU*AH472M13S		4700		14.0			

- The special parts only improve surge withstanding, but can't independently be used in protecting application against surges.)

4. Taping Format:

Part number: □□0AH□□□□□□□□AMD□B

- 25.4mm pitch/lead spacing 10.0mm taping

Lead Code: *BAMD0 & *DAMD0 & *XAMD0

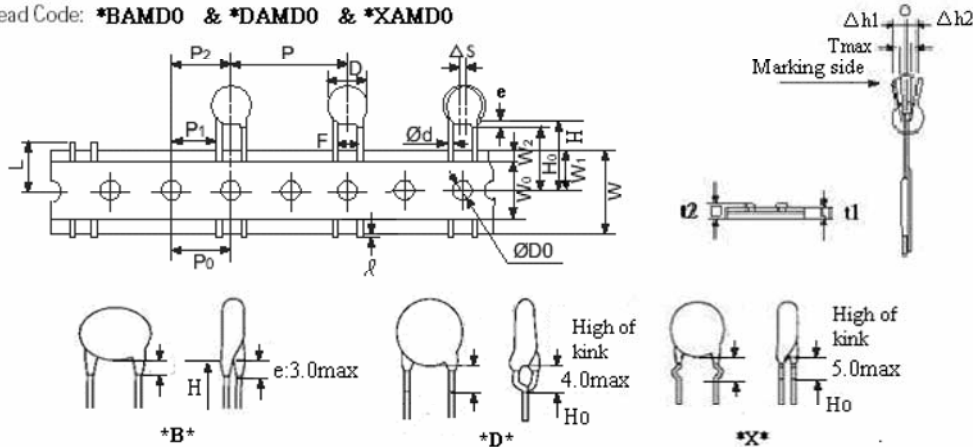

POE Part Number		*BAMD0 / *DAMD0 / *XAMD0
Item	Symbol	Dimensions(mm)
Pitch of component	P	25.4 ± 2
Pitch of sprocket	P0	12.7 ± 0.3
Lead spacing	F	10.0 ± 1.0
Length from hole center to component center	P2	12.7 ± 1.5
Length from hole center to lead	P1	7.7 ± 1.5
Body diameter	D	See the “3. Part numbering/T.C/Capacitance/ Tolerance/Diameter”
Deviation along tape, life or right	△S	0 ± 2.0
Carrier tape width	W	18.0 +1/ -0.5
Position of sprocket hole	W1	9.0 ± 0.5
Lead distance between the kink and center of sprocket hole	H0	18.0 +2.0/-0 (For: *DAMD0 & *XAMD0)
Lead distance between the bottom of body and the center of sprocket hole	H	20.0+1.5/-1.0 (For: *BAMD0)
Protrusion length	ℓ	2.0max (Or the end of lead wire may be inside the tape.)
Diameter of sprocket hole	D0	4.0 ± 0.2
Lead diameter	ϕd	0.5 ± 0.1
Total tape thickness	t1	0.6 ± 0.3
Total thickness, tape and lead wire	t2	1.5 max.
Deviation across tape	△h1	2.0 max.
	△h2	2.0 max
Portion to cut in case of defect	L	11.0 max.
Hole-down tape width	W0	8.0 min
Hole-down tape distortion	W2	1.5 ± 1.5
Coating extension on leads	e	3.0 max for straight lead style; Not exceed the kink leads for kink lead.
Body thickness	T	See the “3. Part numbering/T.C/Capacitance/ Tolerance/Diameter”

6. Scope:

THIS SPECIFICATION APPLIES TO CERAMIC INSULATED CAPACITORS DISK TYPE USED IN ELECTRONIC EQUIPMENT.

6.1 Applicable safety standard

This specification applies to the VDE, SEV, SEMKO, FIMKO, NEMKO, DEMKO, KEMA, KTL, UL, CSA approved ceramic capacitors disc type for antenna coupling, line-by-pass and across-the-line. X1, Y1 capacitor based on IEC384-14 3rd edition. "UL, CSA recognized capacitor for across-the-line, line-by-pass" and antenna-isolation.

6.2 Safety standards approval and recognized no.

Safety Standard	Standard No.	Subclass	w.v.	Recognized No.
UL	ANSI/UL 60384-14:2009	X1	400VAC	E146544
		Y1	250VAC/400VAC	
CSA	CAN/CSA E60384-14:2009	X1	400VAC	2347971
		Y1	250VAC/400VAC	
VDE (ENEC)	IEC60384-14 (ed.3) 2005	X1	400VAC	40001804
		Y1	250VAC/400VAC	
SEV	IEC 60384-14: (ed3)2005	X1	400VAC	11.0325
		Y1	250VAC/400VAC	
SEMKO	IEC 60384-14: (ed3)2005	X1	400VAC	1110795
		Y1	250VAC/400VAC	
FIMKO	IEC 60384-14: (ed3)2005	X1	400VAC	NCS/FI 24755
		Y1	250VAC/400VAC	
NEMKO	IEC 60384-14: (ed3)2005	X1	400VAC	No.P11214078
		Y1	250VAC/400VAC	
DEMKO	IEC 60384-14: (ed3)2005	X1	400VAC	D-00038
		Y1	250VAC/400VAC	
DEKRA (KEMA)	IEC 60384-14: (ed3)2005	X1	400VAC	2150105.02
		Y1	250VAC/400VAC	
CQC	GB/T 14472-1998	X1:400VAC /Y1:400VAC		CQC03001003673
		X1:400VAC /Y1:250VAC		CQC11001055510
KTL	K60384-14	X1	400VAC	SU03017-4004B
		Y1	250VAC	SU03017-4003A

7. Specification and test method:

7.1 Operating Temperature Range: -25 to +125°C

7.2 Test condition:

Test and measurement shall be made at the standard condition. (temperature 15~35°C, relative humidity 45~75% and atmospheric pressure 860~1060hpa). Unless otherwise specified herein.

If doubt occurred on the value of measurement, and measurement was requested by customer capacitors shall be measured at the reference condition. (temperature 20±2°C or 25 ± 2°C, relative humidity 60~70% and atmospheric pressure 860~1060hpa.)

7.3 Performance:

No	Items	Performance	Testing method												
7.3.1	Appearance And dimension	The appearance and dimension shall be as given in section 3.	Visual check.												
7.3.2	Marking	The marking shall be easily legible. (As given section 5)	Visual check.												
7.3.3	Withstand voltage	Between terminals	No failure. The capacitors shall not be damage when AC4000V (rms.) are applied between the lead wires for 60sec.												
		Body Insulation	No failure. First. The terminals of the capacitor shall be closely wrapped around the body of the capacitor distance of about 3 to 4mm from each terminal. Then, the capacitor shall be inserted into a container filled with metal balls of about 1mm diameter. Finally, AC4000V (rms.) is applied for 60sec between the capacitor lead wires and metal balls.												
7.3.4	Insulation Resistance	Between terminals 10000MΩ or more.	The insulation resistance shall be measured with DC500±50V within 60±5sec of charging.												
7.3.5	Capacitance	Within specified tolerance.	B&E&F: The capacitance shall be measured at 20±2°C with 1kHz±20% and 5V(rms.) or less. CH&SL: The capacitance shall be measured at 25°C with 1MHz±20% and 1.0±0.2Vrms												
7.3.6	Dissipation Factor(tanδ) or Q	B、E : D.F. ≤ 2.5% F : D.F. ≤ 5.0% CH&SL : 30pF&above: ≥ 1000 Below 30PF: ≥ 400+20×C													
7.3.7	Temperature Characteristic	Char.	The capacitance measurement shall be made at each step specified in Table 1. Table 1 <table border="1" style="margin-left: auto; margin-right: auto;"> <thead> <tr> <th>Step</th> <th>Temperature (°C)</th> </tr> </thead> <tbody> <tr> <td>1</td> <td>+20±2</td> </tr> <tr> <td>2</td> <td>-25±2</td> </tr> <tr> <td>3</td> <td>+20±2</td> </tr> <tr> <td>4</td> <td>+85±2</td> </tr> <tr> <td>5</td> <td>+20±2</td> </tr> </tbody> </table>	Step	Temperature (°C)	1	+20±2	2	-25±2	3	+20±2	4	+85±2	5	+20±2
		Step		Temperature (°C)											
1	+20±2														
2	-25±2														
3	+20±2														
4	+85±2														
5	+20±2														
Capacitance Change															
B	Within ± 10%														
E	Within ± ² / ₅ %														
F	Within -80 ~ +30%														
CH	0±60ppm/°C														
SL	-1000~+350 ppm/°C (+20°C~+85°C)														
		Pre-treatment: Capacitor shall be stored at 85±2°C for 1hour, then placed at ^{※1} room condition for 24±2hours before measurements.													
7.3.8	Solderability of Leads	Lead wire should be soldered with uniform coating on the axial direction over 3/4 of the circumferential direction.	The lead wire of capacitor should be dipped into molten solder for 5 ± 0.5 sec. The depth of immersion is up to about 1.5 to 2.0 mm from the root of lead wires. Temp. of solder : Lead Free Solder (Sn-3Ag-0.5Cu) 245±5°C												

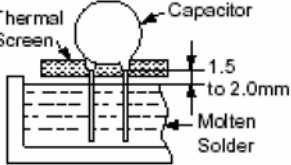
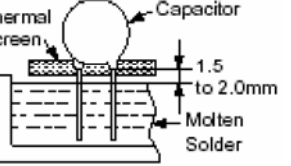
No	Items	Performance	Testing method
7.3.9	Robustness of Terminations	Tensile Lead wire shall not cut off. Capacitor shall not be broken.	With the termination in its normal position, the specimen is held by its body in such a manner that the axis of the termination is vertical; the tensile force of 10N shall be applied to the termination in the direction of its axis and acting in a direction away from the body of the specimen.
		Bending Lead wire shall not cut off. Capacitor shall not be broken.	With the termination in its normal position, the specimen is held by its body in such a manner that the axis of the termination is vertical; a mass applying a force of 5N is then suspended from the end of the termination. The body of the specimen is then inclined, within a period of 2 to 3sec, through an angle of approximately 90° in the vertical plane and then returned to its initial position over the same period of time; this operation constitutes one bend. One bend immediately followed by a second bend in the opposite direction.
7.3.10	Soldering Effect (Non-Preheat)	Appearance No marked defect.	As shown in figure, the lead wires should be immersed in solder of $350 \pm 10^\circ\text{C}$ or $260 \pm 5^\circ\text{C}$ up to 1.5 to 2.0 mm from the root of terminal for 3.5 ± 0.5 sec (10 ± 1 sec. for $260 \pm 5^\circ\text{C}$). 
		I.R. 1000 MΩ min.	
		Dielectric Strength Per item 7.3. 3	
		Capacitance B,E,F : Within $\pm 10\%$ SL,CH: Within $\pm 2.5\%$ or $\pm 0.25\text{pF}$, Whichever is large.	
7.3.11	Soldering Effect (On-Preheat)	Appearance No marked defect.	First the capacitor should be stored at $120 \pm 0/-5^\circ\text{C}$ for $60 \pm 0/-5$ sec. Then, as in figure, the lead wires should be immersed solder of $260 \pm 0/-5^\circ\text{C}$ up to 1.5 to 2.0 mm from the root of terminal for $7.5 \pm 0/-1$ sec. 
		I.R. 1000 MΩ min.	
		Dielectric Strength Per item 7.3.3	
		Capacitance B,E,F : Within $\pm 10\%$ SL,CH: Within $\pm 2.5\%$ or $\pm 0.25\text{pF}$, Whichever is large.	

No	Items	Performance	Testing method			
7.3.12	Humidity (Under steady State)	Appearance	No marked defect.			
		Capacitance	B : Within $\pm 10\%$ E : Within $\pm 20\%$ F : Within $\pm 30\%$ SL&CH: Within $\pm 2.5\%$ or $\pm 0.25\text{pF}$, Whichever is large.			
		D.F.	B,E : 5.0% max. F : 7.5% max.			
7.3.13	Humidity Loading	Q	SL&CH: Less than 30pF= \Rightarrow $Q \geq 100 + 10 \times C/3$ More than 30pF= \Rightarrow $Q \geq 200$			
		I.R.	B,E,F : 3000M Ω min. SL&CH: 1000M Ω min.			
		Dielectric Strength	Per Item 7.3.3			
7.3.14	Life	Appearance	No marked defect.			
		Capacitance	B,E,F : Within $\pm 20\%$ SL&CH: Within $\pm 3\%$ or $\pm 0.3\text{pF}$, Whichever is large.			
		I.R.	3000M Ω min. SL&CH: 1000M Ω min.			
		Dielectric Strength	Per Item 7.3.3			
7.3.15	Flame Test	The capacitor flame discontinues as follows.	The capacitor shall be subjected to applied for 15 sec and then removed for 15 sec until 5 cycles. Fig. 5			
		<table border="1"> <thead> <tr> <th>Cycle</th> <th>Time</th> </tr> </thead> <tbody> <tr> <td>1~4</td> <td>30sec max.</td> </tr> <tr> <td>5</td> <td>60sec max.</td> </tr> </tbody> </table>		Cycle	Time	1~4
Cycle	Time					
1~4	30sec max.					
5	60sec max.					

Set the capacitor for 500 \pm 12hours at 40 \pm 2 $^{\circ}$ C in 90 to 95% relative humidity.
Then capacitor shall be stored for 1 to 2 hours at *1 room condition.

Apply the rated voltage for 500 \pm 12 hours at 40 \pm 2 $^{\circ}$ C in 90 to 95% relative humidity and set it for 1 to 2 hours at *1 room condition.

Impulse Voltage
Each individual capacitor shall be subjected to 8kV impulses for three times. After the capacitors are applied to life test.

Fig. 2

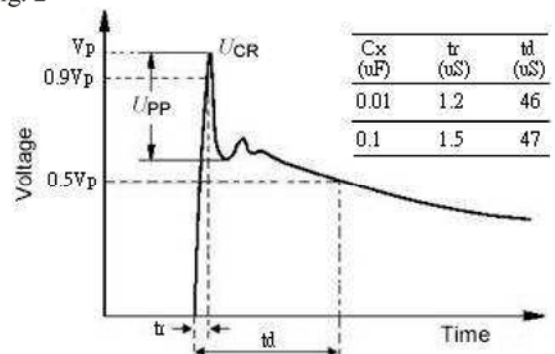

The specimen capacitors are placed in a circulating air oven for a period of 1000 hours. The air in the oven is maintained at a temperature of 125 \pm 3 $^{\circ}$ C. Throughout the test, the capacitors are subjected to an AC425Vrms.(for 0AH type) or AC680Vrms.(for 1AH type) alternating voltage of mains frequency, except that once each hour the voltage is increased to AC1000V(rms.) for 0.1 sec.

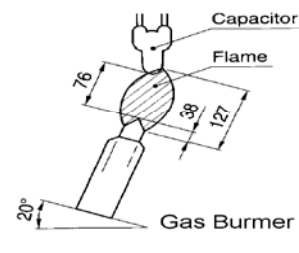

(unit: mm)

8.Packing Baggage :

8.1 Packing size:

	Box	Carton
Bulk	<p>(Four bags in a box)</p>	<p>(Eight boxes in a carton)</p>
Ammo taping	<p>Unit: mm</p>	<p>Unit: mm (Ten boxes in a carton)</p>
	<p>Unit: mm</p>	<p>Unit: mm (Ten boxes in a carton)</p>
	<p>Unit: mm</p>	<p>Unit: mm (Ten boxes in a carton)</p>

8.2 Packing quantity:

Type of packing	One bag	One box	One carton
Bulk	500pcs	1000pcs~2000pcs	8000pcs~16000pcs
	200pcs	1000pcs	8000pcs
Ammo taping (AF-Product pitch:15.0mm)	--	1000pcs	10000pcs
Ammo taping (AM-Product pitch:25.4mm)	--	500pcs	5000pcs

9. Notices:

9.1 Caution (Rating):

(1). Operating Voltage

Be sure to maintain the V_{p-p} value of the applied voltage or the V_{0-p} which contains DC bias within the rated voltage range.

When the voltage is started to apply to the circuit or it is stopped applying, the irregular voltage may be generated for a transit period because of resonance or switching. Be sure to use a capacitor within rated voltage containing this irregular voltage.

Voltage	DC Voltage	DC+AC Voltage	AC Voltage	Pulse Voltage (1)	Pulse Voltage (2)
Positional Measurement					

(2). Operating Temperature and Self-generated Heat

Keep the surface temperature of a capacitor below the upper limit of its rated operating temperature range. Be sure to take into account the heat generated by the capacitor itself.

When the capacitor is used in a high-frequency current, pulse current or the like, it may have the self-generated heat due to dielectric-loss.

Applied voltage should be the load such as self-generated heat is within 20°C on the condition of atmosphere temperature 25°C . When measuring, use a thermocouple of small thermal capacity-K of $\phi 0.1\text{mm}$ and be in the condition where capacitor is not affected by radiant heat of other components and wind of surroundings. Excessive heat may lead to deterioration of the capacitor's characteristics and reliability.

(3). Test condition for withstanding Voltage

I. Test Equipment

Test equipment for AC withstanding voltage shall be used with the performance of the wave similar to 50/60 Hz sine waves.

If the distorted sine wave or over load exceeding the specified voltage value is applied, the defective may be caused.

II. Voltage Applied Method

When the withstanding voltage is applied, capacitor's lead or terminal shall be firmly connected to the output of the withstanding voltage test equipment, and then the voltage shall be raised from near zero to the test voltage.

If the test voltage without the raise from near zero voltage would be applied directly to capacitor, test voltage should be applied with the *zero cross. At the end of the test time, the test voltage shall be reduced to near zero, and then capacitor's lead or terminal shall be taken off the output of the withstanding voltage test equipment.

If the test voltage without the raise from near zero voltage would be applied directly to capacitor, the surge voltage may arise, and therefore, the defective may be caused.

ZERO CROSS is the point where voltage sine wave pass 0V.- See the right figure.

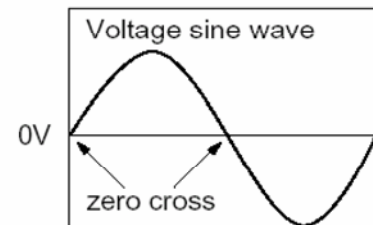

(4). Fail-Safe

When capacitor would be broken, failure may result in a short circuit. Be sure to provide an appropriate fail-safe function like a fuse on your product if failure would follow an electric shock, fire or fume.

Failure to follow the above cautions may result, worst case, in a short circuit and cause fuming or partial dispersion when the product is used.

9.2 Caution (Storage and operating condition):

Operating and storage environment

The insulating coating of capacitors does not form a perfect seal; therefore, do not use or store capacitors in a corrosive atmosphere, especially where chloride gas, sulfide gas, acid, alkali, salt or the like are present. And avoid exposure to moisture. Before cleaning, bonding, or molding this product, verify that these processes do not affect product quality by testing the performance of a cleaned, bonded or molded product in the intended equipment. Store the capacitors where the temperature and relative humidity do not exceed -10 to 40 degrees centigrade and 15 to 85 %. Use capacitors within 6 months.

"Failure to follow the above cautions may result, worst case, in a short circuit and cause fuming or partial dispersion when the product is used."

9.3 Caution (Soldering and Mounting):

9.3.1 Vibration and impact:

Do not expose a capacitor or its leads to excessive shock or vibration during use.

9.3.2 Soldering:

When soldering this product to a PCB/PWB, do not exceed the solder heat resistance specification of the capacitor. Subjecting this product to excessive heating could melt the internal junction solder and may result in thermal shocks that can crack the ceramic element.

When soldering capacitor with a soldering iron, it should be performed in following conditions.

Temperature of iron-tip: 400 degrees C. max.

Soldering iron wattage: 50W max.

Soldering time: 3.5 sec. max.

9.3.3 Cleaning (ultrasonic cleaning):

To perform ultrasonic cleaning, observe the following conditions.

Rinse bath capacity: Output of 20 watts per liter or less.

Rinsing time: 5 min maximum.

Do not vibrate the PCB/PWB directly.

Excessive ultrasonic cleaning may lead to fatigue destruction of the lead wires.

"Failure to follow the above cautions may result, worst case, in a short circuit and cause fuming or partial dispersion when the product is used."

9.4 Caution (Handling):

Vibration and impact

Do not expose a capacitor or its leads to excessive shock or vibration during use.

"Failure to follow the above cautions may result, worst case, in a short circuit and cause fuming or partial dispersion when the product is used."

10. Drawing of internal structure and material list:

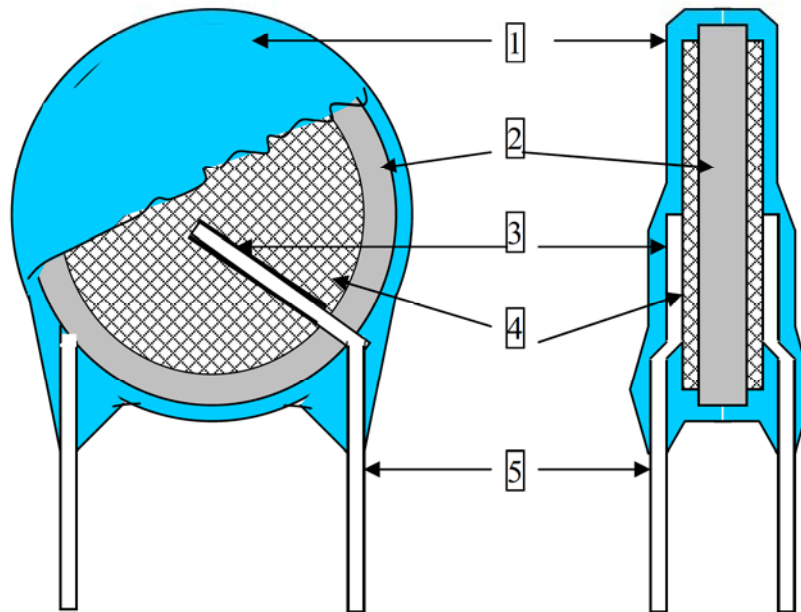

Remarks :

No.	Part name	Material	Model/Type	Component
1	Insulation Coating	Epoxy polymer	1.EF-150C 2.EF-150(HF) 3.PCE-210 2.PCE-300(HF)	Epoxy resin、Pigment (Blue / UL 94 V-0 /) The minimum thickness of coating (reinforced insulation) is 0.4mm
2	Dielectric Element	Ceramic	CH/SL/Y5P/Y5U/Y5V	BaTiO ₃
3	Solder	Tin-silver	Sn96.5-Ag3-Cu0.5	Sn96.5-Ag3-Cu0.5
4	Electrodes	Ag	1.SP-160PL 2.SP-260PL	Silver、Glass frit
5	Leads wire	Tinned copper clad steel wire	0.6+0.1/-0.05mm	Substrate metal: Fe & Cu Surface plating: Sn 100%(3~7μm)